

Article number: 01010431  
 Description: Retaining ring A 26 DIN 471  
 Stainless 411  
 Note: Fitted with ZGA pilers

## Measures

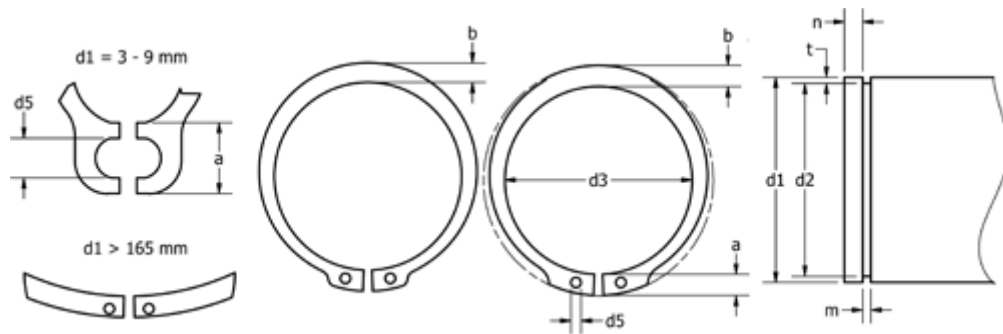

a max	= 4.5	FN kN	= 7.3	s	= 1.20
AN mm <sup>2</sup>	= 44.0	FRg kN	= 3.70	t	= 0.55
b	= 3.1	FR kN	= 16.10	tol	= -0.21
d1	= 26	g	= 1.5	tol	= -0.06
d2	= 24.9	K kN-mm	= 32.90	tol	= +0,21-0,42
d3	= 24.2	m min	= 1.30	Tong	= ZGA-2
d5 min	= 2.0	n abl x 1000	= 24.0	Weight kg/1000	= 1.960
Description	= A26	Nominal drive	= 1.7		